



# MR-24<sup>®</sup>

Roof system

---

Industry's first & finest  
Standing-Seam Metal Roof System

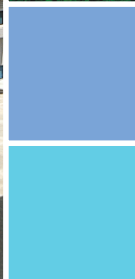

Tata BlueScope Steel has always maintained consistency with best in class products driven by Quality and Innovation. Our solutions are an outcome of an in-depth understanding of our customers' requirements, addressing the ever growing complexities within building & construction ecosystem. MR-24® roof system is just one of the reasons why Tata BlueScope Steel is an architect's first choice! With 50 years of global presence, MR-24® is the most time-tested and widely used standing-seam roof system.

## Standing Seam Roof System

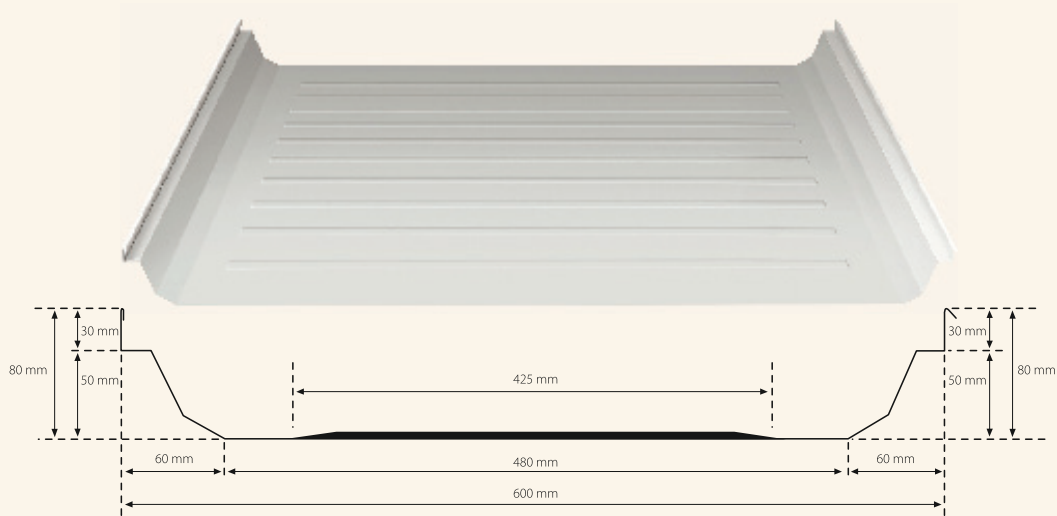

Base metal thickness (BMT)	0.60	0.72
Total coated thickness (TCT)	0.65	0.77
Effective coverage width	600	600
Rib depth	50	50
(All dimensions are in mm)		
<b>Mass</b>	<b>ZINCALUME® steel</b>	
Mass per unit area Kg/m <sup>2</sup>	5.97	7.12
<b>Mass</b>	<b>COLORBOND® steel</b>	
Mass per unit area Kg/m <sup>2</sup>	6.05	7.20

Above spans are applicable up to wind speed of 44m/sec. Supports must be not less than 1 mm BMT. Please contact Tata BlueScope Steel office considering the above for designs.

### Roof pitch

Minimum recommended pitch	1.2°
Grade of steel	G345 (345 MPa Yield strength)
Coating class (min.)	AZ150 onwards

**Tata BlueScope Steel has FM Approved MR-24® panel assemblies for wind class rating upto I-180. (Ratings approved are I-60, I-75, I-90, I-105, I-120, I-135, I-180)**

# MR-24<sup>®</sup> Roof System Difference

## 1 Weathertight Seams

Protect against leaks

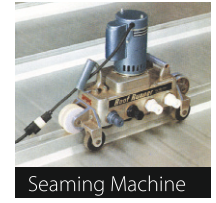
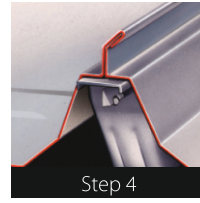
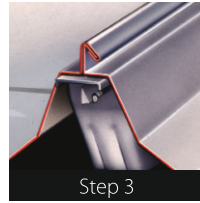
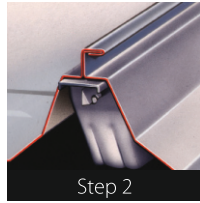
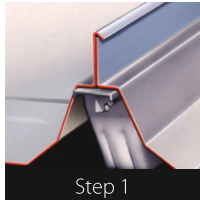

The MR-24<sup>®</sup> Roof System is the only standing seam roof system where the critical 180 degrees of the roof panel seam is mechanically seamed on-site to complete a 360<sup>°</sup> Pittsburgh Double-Lock seam creating the tightest seam available today. The Pittsburgh double-lock seam is the same design used to seal soft drink cans. Panels of other

roof systems may simply snap together or be crimped, leaving them too weak to withstand foot traffic or wind and ice build ups. Inside the seam, a factory applied sealant assures weathertightness in even the most unforgiving conditions.

## 2 MR-24<sup>®</sup> Roof Clip

Allows the MR-24<sup>®</sup> Roof System to 'truly float'

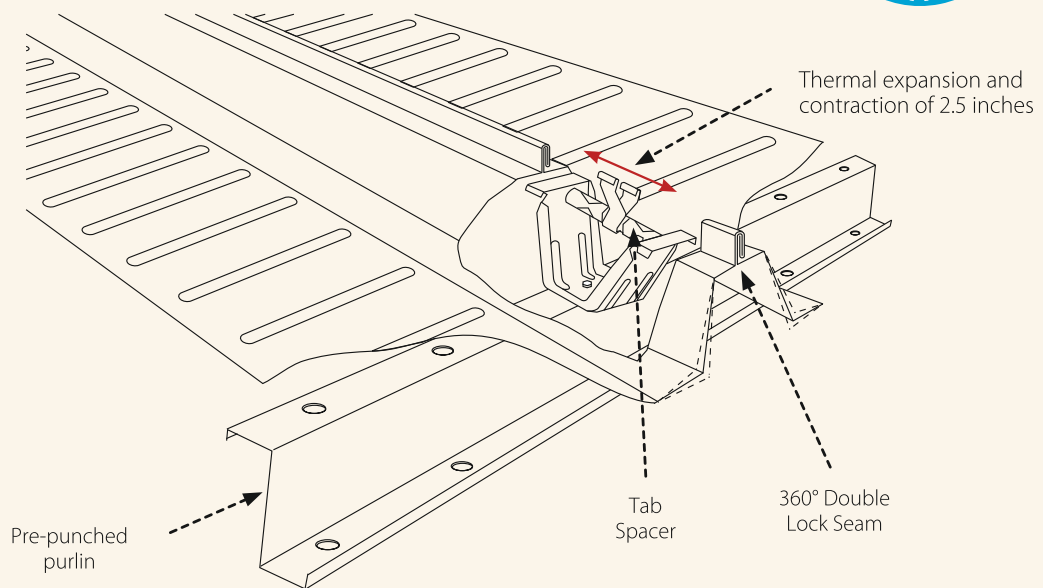

Truly Floating MR-24<sup>®</sup> Roof System

Metal roofs expand and contract with daily and seasonal temperature changes. The MR-24<sup>®</sup> Roof Clip is carefully designed to provide a positive attachment and allows the roof to move freely in both directions. Without this

mobility, the roof panels would tug and pull on the clip, a process that will eventually cut into the roof panels, pull out the fasteners or damage the clip, causing the building to be vulnerable to leaks and wind damage.

The unique features of MR-24<sup>®</sup> Roof Clip are:

- The concave surface of clips ensures that it will not pierce the roof panel during thermal movement.
- A triangular bar with thin cadmium coating provides a smooth surface for tab movement.
- High strength stainless steel tab is 50% stronger than most other standing seam roof system tabs.

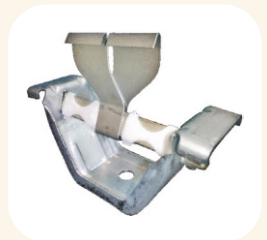

### 3 Cross Flutes

Prevents Panel Distortion



MR-24® Roof Panel comes with cross flutes which enables panel return to original shape even after severe wind uplift force. Cross flutes & Pittsburgh double lock seam helps to withstand panel shape and seam intact even in higher

human traffic. The MR-24® roof system carries the highest wind uplift rating (Class 90) awarded by Underwriters Laboratories. It is also tested and approved by FM Global as a Class 1 Panel roof system.

### 4 Factory Punching

Creates perfect alignment

Proper alignment of roof panels is crucial to roof performance. Poor alignment affects weathertightness and creates problem when installing closures, roof accessories and trim. All roof panels and structural members of the MR-24® roof system are factory-punched to ensure proper alignment.



MR-24® Roof

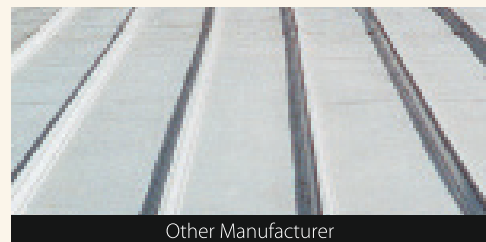

Other Manufacturer

### 5 Splice Support

Secures solid structures

On wider buildings, roof panels are placed end to end, creating a splice. Other Standing seam system allow their splices to occur in midair - without direct structural support. Installers and other roof traffic, even the rain-water weight,

will push down on midair splices and cause strain on the splice, providing the opportunity for the splice to open. MR-24® roof system prevents this by designing splice locations to occur directly over supporting steel.

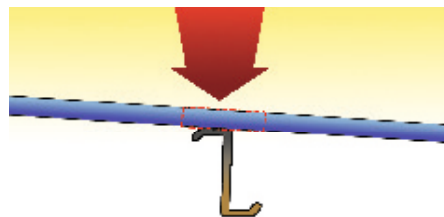

MR-24®

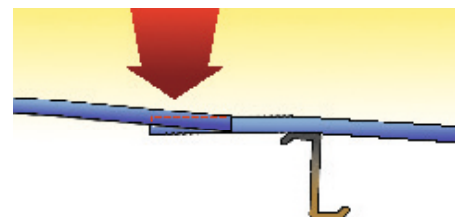

Other Manufacturer



## 6 Stronger Fasteners

Maintain incredible strength

MR-24® roof system has factory punched structurals, and we use fasteners as per AS 3566 for clip and panel attachment. The high-strength fastener has twice the pullout strength of industry-standard self-drillers. It takes two to three times the number of self-drilling screws to equal the performance of one MR-24® roof system bolt.

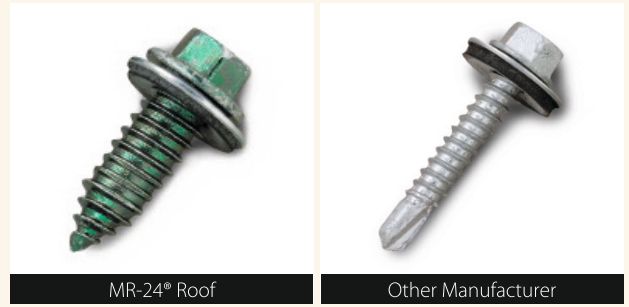

## 7 Staggered Panel Splices

Prevent exposed seams

Most manufacturers locate panel splices at exactly the same position across the entire roof.

This creates a condition where four panel corners must be joined at the same location, making it almost impossible to seal and keep weathertight. MR-24® staggers the factory notched panel splices to avoid this condition, to assure weathertightness and to provide a stronger and superior roof system.

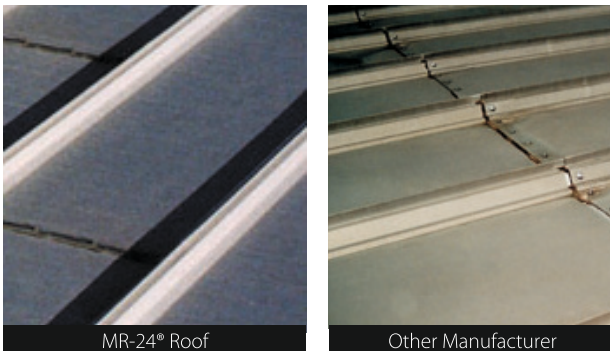

## 8 Sealants

Assures leak-tight performance

Sealant for MR-24® has been developed by our in-house Research and Development Centre. It has a higher butyl rubber percentage that enables leak-tight sealing at the joints. All Butler Mastic contains unique 'Nylon Cubes' that allow erectors to tighten the splice joints and stay confident that they have left uniform bead of sealant ensuring weather tightness.



## 9 Roof Curb Openings

Precision engineering

MR-24® roof system approved roof opening is fully engineered at the factory, ensuring no requirement of field engineering. Unlike the exposed fastener designs used

by other manufacturers, MR-24® roof system's internal flange design conceals fasteners within the opening and eliminates leaks.

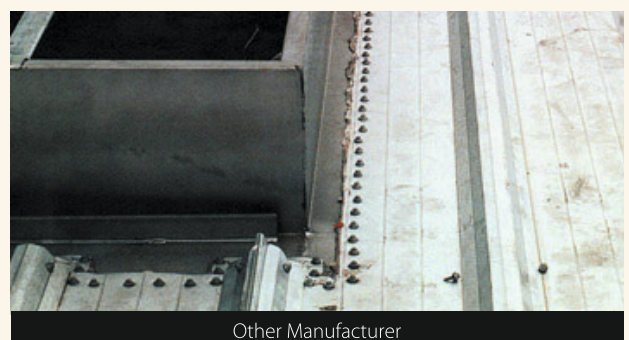
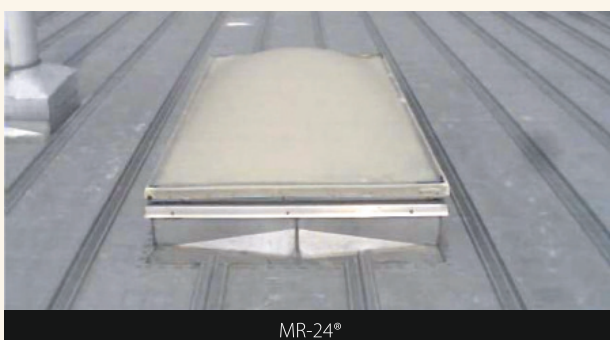

# Generic Guidelines

## Roof Panels

1. Roof Panel shall be factory roll-formed MR-24™ roof system 600 mm wide with two major corrugations, 50 mm high (80 mm including seam). The flat of the panel shall contain cross flutes 430 mm on centre perpendicular to the major corrugations the entire length of the panel to reduce wind noise and improve walkability.
2. Panel of maximum transportable length shall be used to minimize end lap; eave panels shall extend beyond the structural line of the sidewall.
3. Panels shall be factory punched at panel end to match punched holes in the eave structural member. Panel end splice shall be factory punched and pre-notched. Panel end splice shall be floating and allow the roof panel to expand and contract with roof panel temperature change.
4. Ridge assembly shall be designed to allow roof panel temperature changes. Parts shall be factory punched for correct field assembly. Panel closure and interior reinforcing strap shall be installed to seal the panel end at the ridge. The attachment fasteners shall not be exposed on the weather side. A hi-tensile steel ridge cover shall span from panel closure to panel closure and flex as the roof system expands and contracts.

## System Design

1. All components of the MR-24™ roof system paneling shall be designed in accordance with sound engineering methods and practices.
2. MR-24™ roof system panel shall be designed in accordance with AISI "Specification for Design of Light Gauge, Cold Formed Steel Structural Members".
3. Panel system shall be designed to support design live load.
4. All endwall trim and roof transition flashing shall allow

the roof panel to move relative to the wall panel and/or the parapet as the roof expands and contracts with temperature change.

5. The MR-24™ roof system panel shall not be considered to be a safe work platform until completely secured to the structural system. Therefore, walkboards or other safety equipment as required by safety standards shall be provided by the erecting contractor to provide for worker safety during installation.

## System Installation

1. Panel clips shall be positioned by matching the hole in the clip with the factory-punched holes in the secondary structural members.
2. Panel shall be positioned and properly aligned by matching the factory punched holes in the panel end with the factory punched holes in the eave structural member and by aligning the panel with the panel clip.
3. Panel sidelap shall be field-seamed by a self-propelled and portable electrical lock-seaming machine. The machine field forms the final 180 degrees of a 360 degree MR-24™ double-lock standing seam; all sidelap sealant shall be factory applied.
4. Panel endlap, when required, shall be at least 150mm sealed with neutralcure sealant and fastened together by clamping plates. Sealant shall contain hard nylon cubes which prevent it from flowing out due to clamping actions. The panel lap shall be joined by means of a two-piece clamped connection consisting of a bottom reinforcing plate and a top panel strap. The panel endlap shall be located directly over, but not fastened to, a supporting secondary roof structural member and be staggered, so as to avoid a four panel lap splice condition.
5. A minimum blanket insulation thickness of 50 mm is preferred for all MR-24™ roof system applications.



## ZINCALUME® steel & COLORBOND® steel

### Enhance & Protect

MR-24® roof system is manufactured using long lasting ZINCALUME® steel (AZ150 g/m<sup>2</sup> min. zinc/aluminium alloy-coated steel) as per AS1397 or COLORBOND® pre-painted steel conforming to AS2728 Class 3-4 for superior aesthetic appearance.

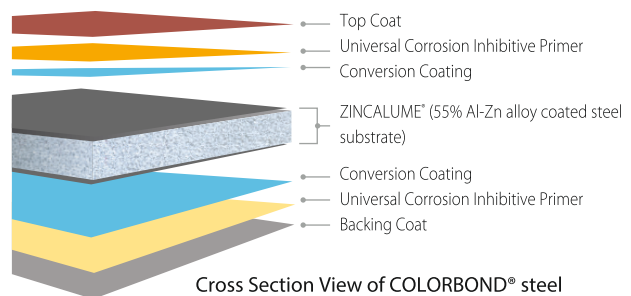

Made of recycled and recyclable steel, MR-24® roofing is inherently green. We offer a wide range of energy-efficient roof and wall systems made from COLORBOND® steel that contains THERMATECH™ technology to help achieve greater thermal efficiency. MR-24® panels are also compatible for mounting solar panels

(For more information log on to [www.tatabluescopesteel.com](http://www.tatabluescopesteel.com))

## Key Differentiators

### Assured On-time Delivery



Delivery commitments based on front of load process



Critical chain project management provides early warning signals for no surprises

### Safe Erection Practices



Dedicated construction safety team



SKY-WEB® Fall Protection System

## Certifications & Memberships



ISO 9001  
ISO 14001  
OHSAS 18001

We have a strong Quality, Environment, Occupational Health and Safety Management System and have received the following certifications: ISO 9001:2015, ISO 14001:2015 and OHSAS 18001:2007.



MR-24® standing seam roof system, MR-24® roof system with liner panel and BR-II™ lap seam roof system are certified by the prestigious Factory Mutual Approval (FM Approvals). The MR-24® Roof System meets the widest range of FM Approvals class. The FM Approvals certified roof systems are widely regarded by all customers as the best-in-class roofs, tested for wind uplift and fire rating.



Tata BlueScope Steel Pvt. Ltd. follows sustainable building design and construction practices that significantly reduce or eliminate the negative impact of buildings on the environment and occupants.

Explore More



**Toll Free: 1800 2708333**  
**Email: [contact@tatabluescopesteel.com](mailto:contact@tatabluescopesteel.com)**

Note:  
©2023 Tata BlueScope Steel Pvt. Ltd. All rights reserved. This brochure and its content is copyright of Tata BlueScope Steel Pvt. Ltd. No part of this brochure may be reproduced or transmitted in any form or by any means, electronic or mechanical including photocopy, recording, or any information storage and retrieval system, without permission in writing from Tata BlueScope Steel Pvt. Ltd.  
All brand names mentioned in this brochure are registered trademarks of BlueScope Steel Limited under license to Tata BlueScope Steel Pvt. Ltd.

Authorised EZYBUILD® Solutions Provider

  
**TATA BLUESCOPE  
STEEL**

Tata BlueScope Steel Pvt. Ltd.  
CIN : U45209PN2005PTC020270,  
Floor no. 9 & 10, Kalpataru Infinia, Wakedwadi, Final Plot  
no. 21, Sub plot no. 3 at CTS no. 15/1 Shivajinagar, Pune  
- 411003, India. | Tel: +91 20 6621 8000  
Website: [www.tatabluescopesteel.com](http://www.tatabluescopesteel.com)