



Global Excellence since 1857



SMARTDEK® 51

Structural Decking System



Overview



LYSAGHT SMARTDEK® 51 Structural Decking System is an innovative high strength zinc-coated steel decking system designed for use in the construction of composite floor slabs. It is specifically developed for the Indian Construction Industry and is one of the most economical structural steel decking in the country. SMARTDEK® 51 system complements the LYSAGHT® profiles, which is a premium range of roofing and wall cladding solutions. The high quality LYSAGHT SMARTDEK®51 Structural Decking System reinforces the principles of trust and reliability that Tata BlueScope Steel represents. SMARTDEK® 51 is suitable for typical construction

application as it provides widest cover per weight of steel and also minimises the requirement for reinforcement. It acts as a permanent formwork for a composite concrete slab, which in its assembled state can be used as a working platform as well as a formwork to support wet concrete, construction materials and trades. When the concrete hardens, it acts as the bottom tensile reinforcement. SMARTDEK® 51 system is a complete structural steel decking system for concrete, masonry and steel frame construction and has an exceptional composite performance.

History of LYSAGHT® Decking Profile

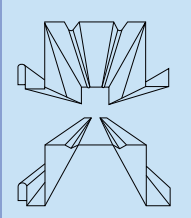
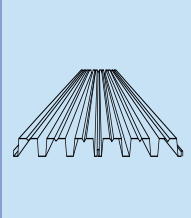
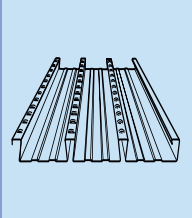
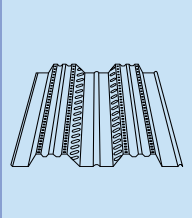
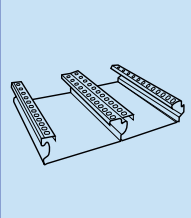
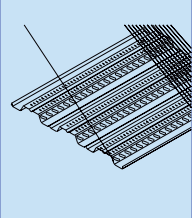
1964	1968	1989	1992	1998	2006
					
TROFDEK®	CELDEK®	BONDEK® II	W-DEK®	POWERDEK®	SMARTDEK® 51

LYSAGHT SMARTDEK® 51 Structural Decking System is an innovative “W” profile structural steel decking system. It brings greater economy and design freedom as it is precision engineered and provides ease of use as well as safety. SMARTDEK® 51 system has excellent spanning capacities that ensure greater strength and less deflection.

SMARTDEK® 51 panel has a rib depth of 51 mm and provides an effective cover width of 960 mm as shown in the figure 1.1. Embossments on top of the flange provide excellent mechanical interlocking between steel and concrete. In the assembled state, the profile comprises of intermediate male and female ribs for every interlocking side-lap joint.

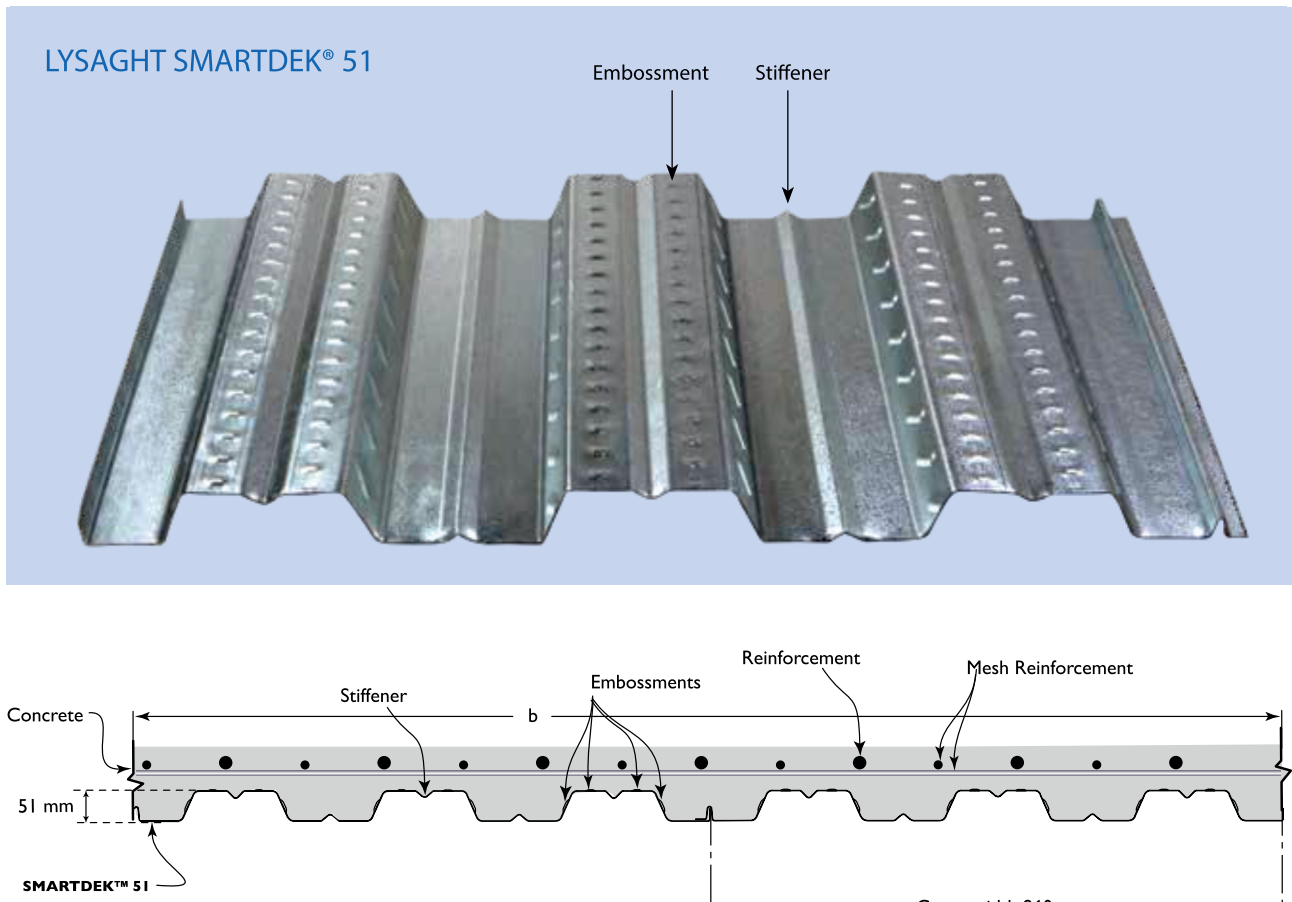

Figure 1.1



Jin Mao Tower, Shanghai, China

SMARTDEK® 51 Section Properties

SMARTDEK® 51 Thickness (BMT) (mm)	Self Weight (kg/m ²)	Full Cross-Sectional Area (mm ² /m)	Zinc Coating g/m ² *)	Steel Grade (MPa)**	Inertia Moment I _x ¹ (mm ⁴ /m)	Section Modulus Z _x ¹ (mm ³ /m)
0.70	7.35	855	275	550	381741	15765
1.00	10.34	1222	275	550	545345	22382
1.20	12.33	1467	275	500	654343	26755





Note:

* Nominal coating thickness

** Minimum yield strength of steel

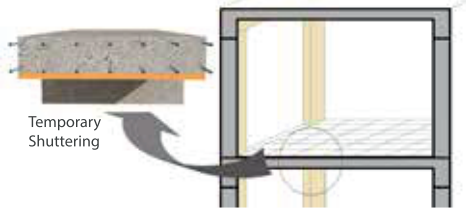
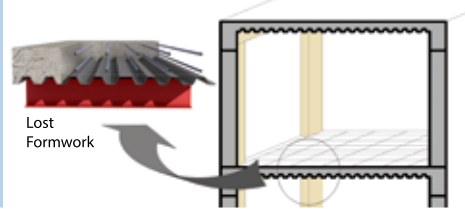
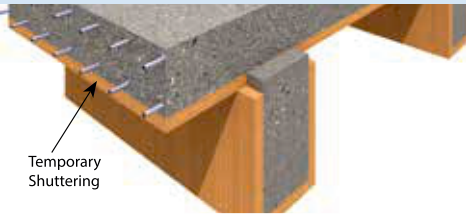
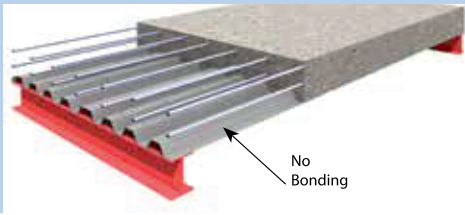
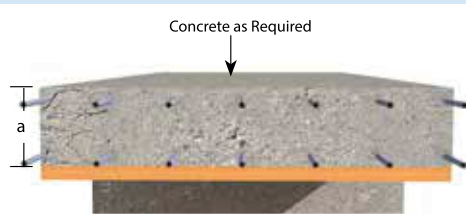
Please contact nearest Tata BlueScope Building Products office for other thickness and coating options

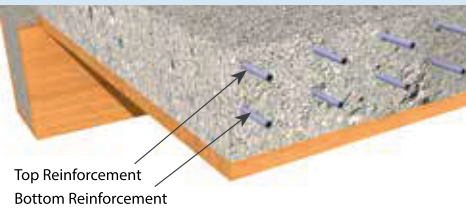
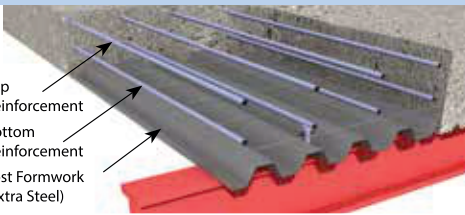
Benefits of LYSAGHT SMARTDEK® 51 system

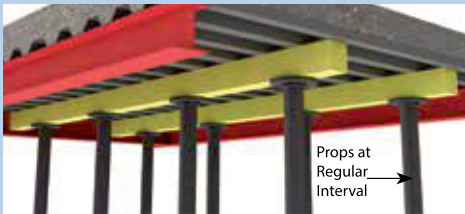
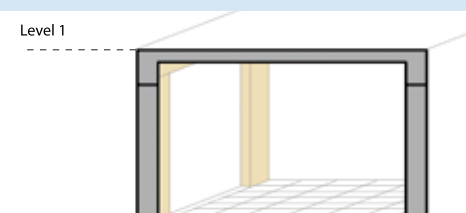
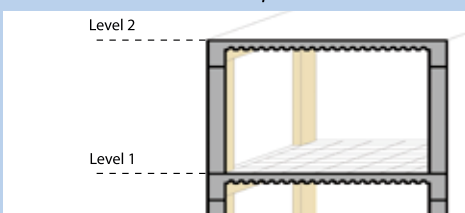
Comparison Chart		Conventional RCC Slab	Lost Formwork Decking Slab	
Structural Element	<i>Temporary Shuttering removed after concrete curing</i>		<i>Decking acts as a lost formwork material</i>	
Composite Action	<i>Temporary Shuttering removed after slab sets</i>		<i>No bonding between steel sheet & concrete</i>	
Concrete Saving	<i>Concrete volume as per required slab depth</i>		<i>Extra concrete required at the profile valleys</i>	
Steel Saving	<i>Reinforcement steel as required</i>		<i>Decking acts as extra steel to the slab</i>	
Prop Arrangement	<i>Requires complex prop arrangement</i>		<i>Reduction in props</i>	
Construction Time	<i>Normal speed of construction</i>		<i>Decking application enhances construction speed</i>	

SMARTDEK® 51 Structural Decking Slab

SMARTDEK® 51 acts as an integral structural element

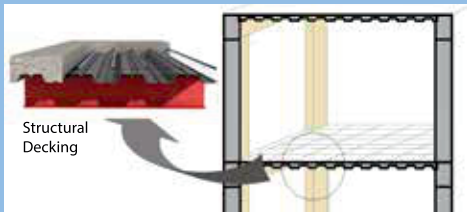

Embossments provide mechanical interlock between steel & concrete

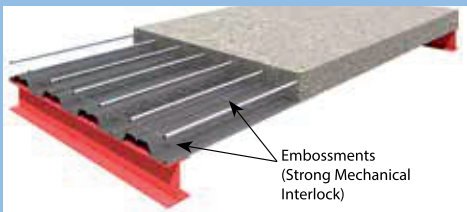

Concrete saving makes construction economical

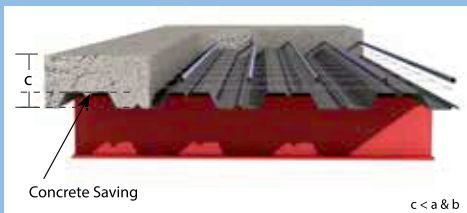

SMARTDEK® 51 acts as bottom tensile reinforcement – Steel Saving

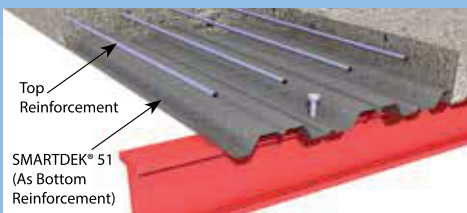

High tensile steel (G550) provides large unpropped spans



SMARTDEK® 51 application delivers faster value to developers

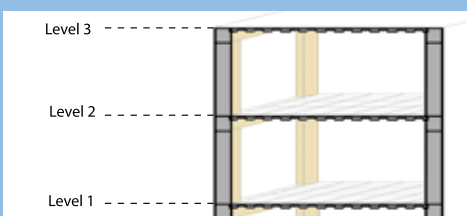

Smart Software

LYSAGHT SMARTDEK® which is designed using a specialized software based on Windows named MEGAFLOOR, has a more economic value and provides flexibility in designing due to its accuracy in size, easy montage and safety features.

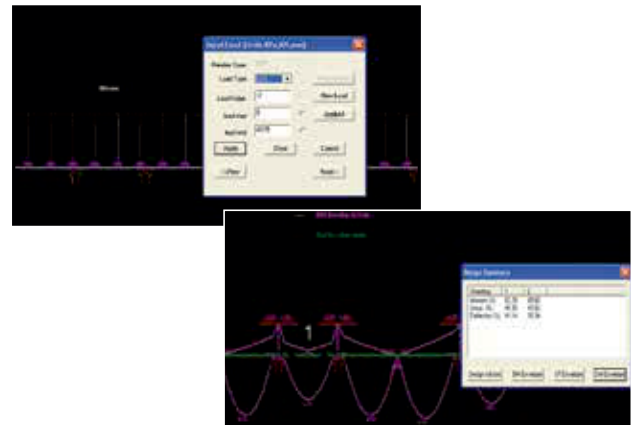

Smart Construction

SMARTDEK® 51 system provides a safe working platform that is fast and easy to set up and therefore minimises multi-storey construction time. Faster construction time allows optimisation on construction schedule delivering faster value to the developers.

Smart Application

Besides its application in composite floors in multi-storey buildings and commercial establishments, it is extensively used for Mezzanine applications. Corrosion resistant coating makes it the best solution for typical applications like parking sheds, where SMARTDEK® 51 system provides better appearance to exposed ceilings.



Specifications

Material Specifications

SMARTDEK® 51 panel is manufactured from hot dipped zinc coated high strength steel with 550 MPa yield strength and coating mass of Z275 (min 275g/m² total of zinc coating on both sides). The available thickness ranges from 0.70 mm to 1.2 mm BMT (Base Metal Thickness). The steel conforms to AS1397 and BS EN 10147:2000.

Optional: SMARTDEK® 51 system is available in pre-painted galvanised steel.



Fig. 2.1 - Formwork - Point Load



Fig. 2.2 - Formwork - Air Pressure Test



Fig. 2.3 - Composite - Slip Block Test



Fig. 2.4 - Fire Test - Victoria University

Tested to Extreme Conditions

SMARTDEK® 51 panels have been subjected to rigorous tests such as slip block test, formwork tests including shear and bearing, full scale slab test, composite slab cycle test, fire rating test, formwork-air pressure test, formwork-four point load test and concentrated load test. These tests are carried out in the labs of LYSAGHT technology centre in Chester Hill, Sydney, Australia, to ensure maximum performance and quality of our decking profiles. (Ref. figure 2.1 to 2.4)

Quality Assurance

The LYSAGHT® brand name is synonymous with quality and performance. As with all other LYSAGHT® products, SMARTDEK® 51 steel sheets comply with major Indian standards and design standards adopted across Asia. Manufactured using high tensile steel, it is optimally configured and uses advanced design and construction method.



Roll Forming Machine

SMARTDEK® Span Table Formwork Stage*

Span Type	Single (mm)			Continuous End (mm)			Continuous interior (mm)		
	0.7	1	1.2	0.7	1	1.2	0.7	1	1.2
Base Metal Thickness	0.7	1	1.2	0.7	1	1.2	0.7	1	1.2
100	2360	2600	2600	2610	3200	3200	2610	3200	3200
110	2280	2620	2800	2520	3290	3580	2520	3130	3340
120	2200	2540	2710	2430	3200	3490	2430	3030	3240
130	2140	2460	2630	2360	3110	3400	2360	2950	3150
140	2080	2400	2560	2290	3040	3320	2290	2840	3070
150	2030	2340	2500	2230	2950	3240	2230	2740	2990
160	1980	2290	2450	2180	2870	3170	2160	2650	2930
170	1930	2240	2390	2120	2800	3100	2090	2570	2840
180	1890	2190	2350	2080	2740	3040	2030	2490	2750
200	1810	2110	2260	1990	2620	2900	1920	2360	2610
220	1740	2040	2190	1910	2510	2790	1820	2240	2480

* Please refer to SMARTDEK® 51 Design and Construction Manual for detail design of composite slab.

The above data has been derived from tests conducted at our research centre and reproduction of the same in any form is strictly prohibited.

Steel Connection Details

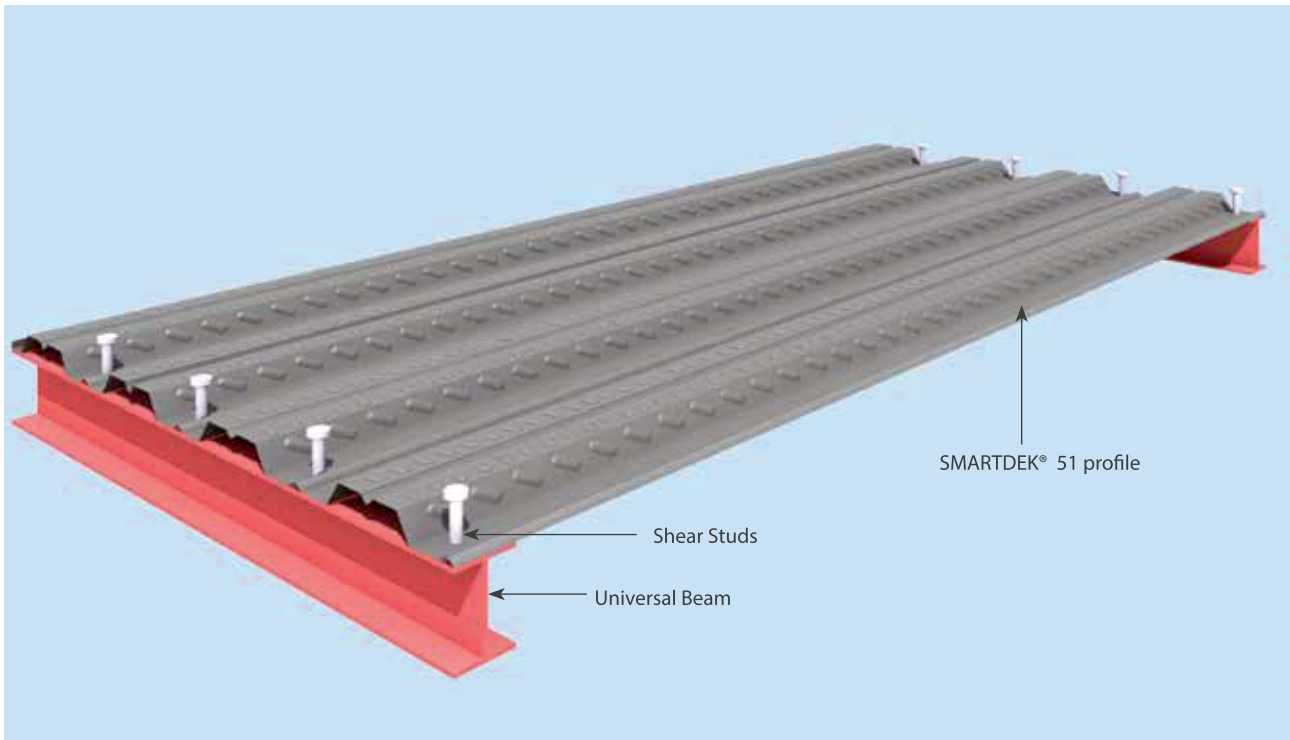

SMARTDEK® 51 fixing detail: The accessories are added as per design requirement

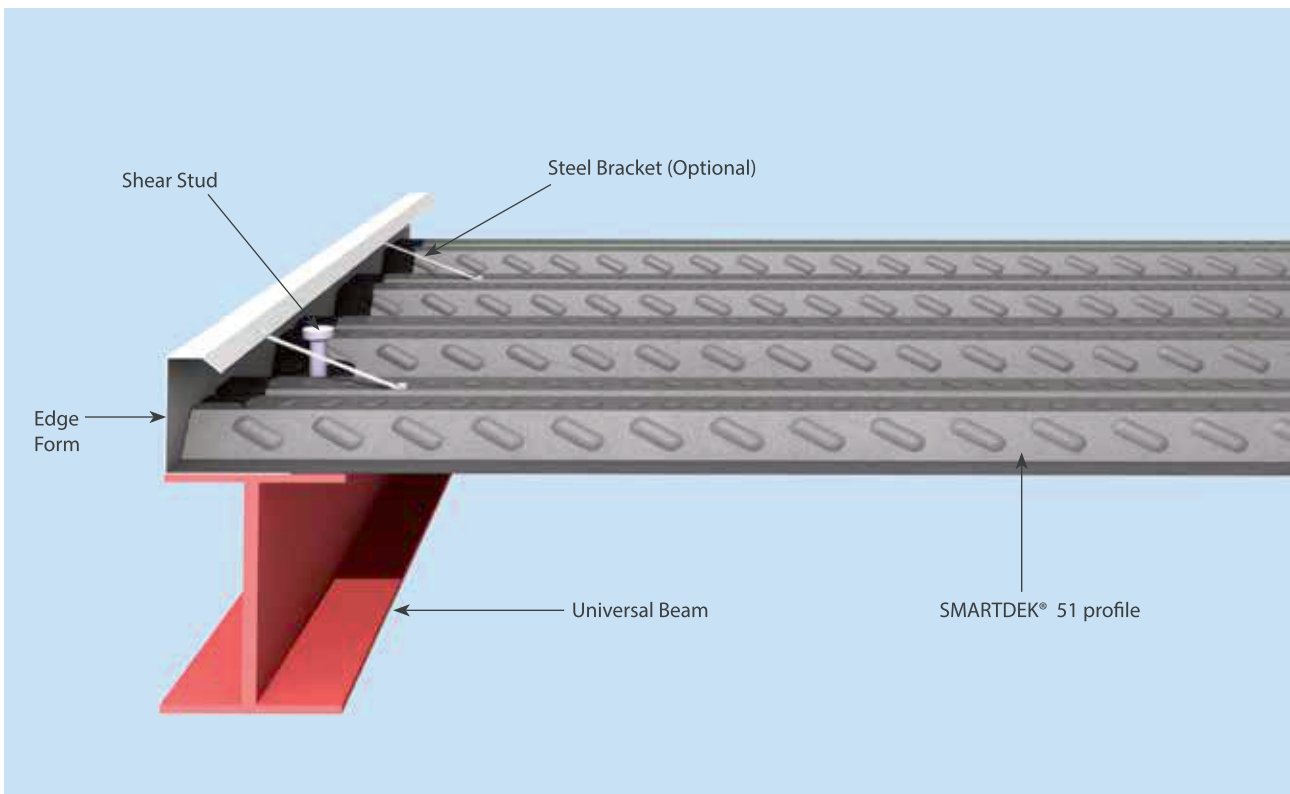

End details-Flush Type: Standard end closure detail adopted for steel frame structure

Above connection details for guidance purpose only.

Connection Details

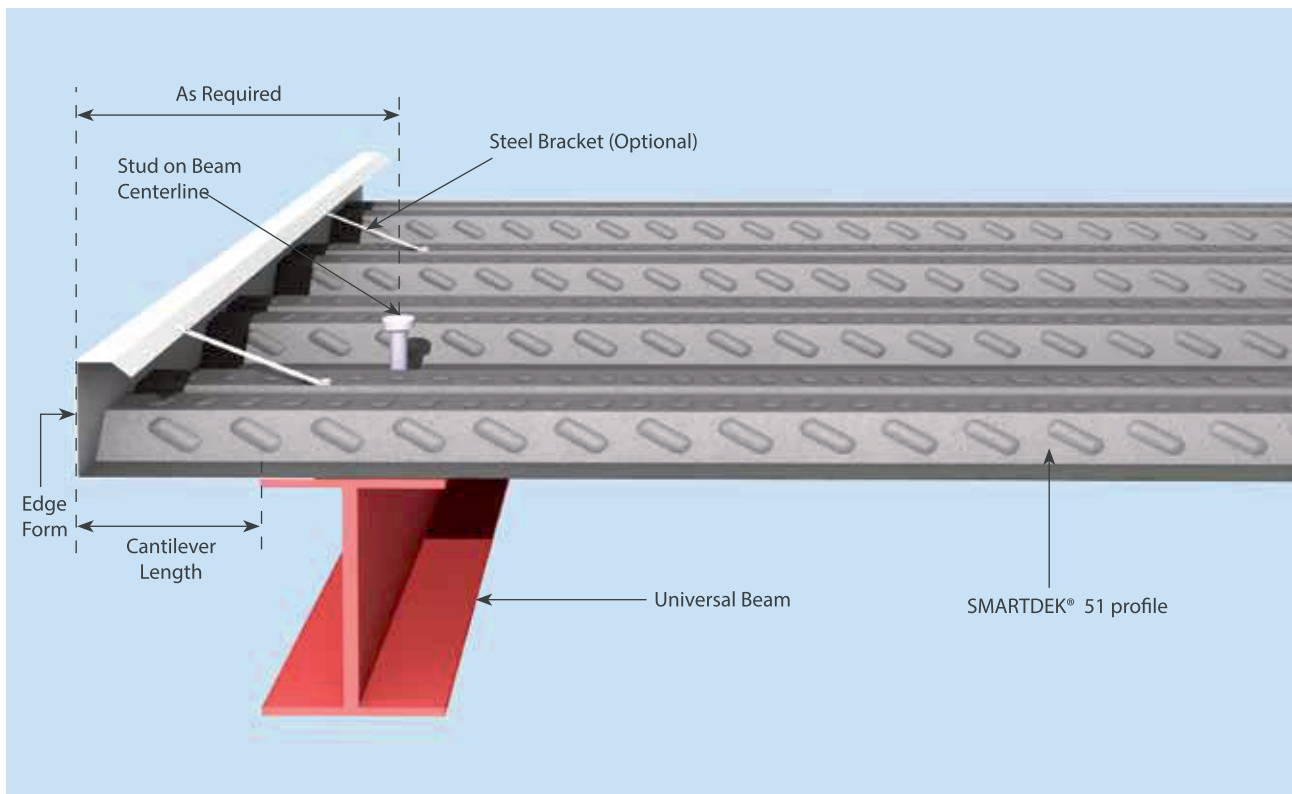

End details - Option 1: Details adopted for cantilever end projections

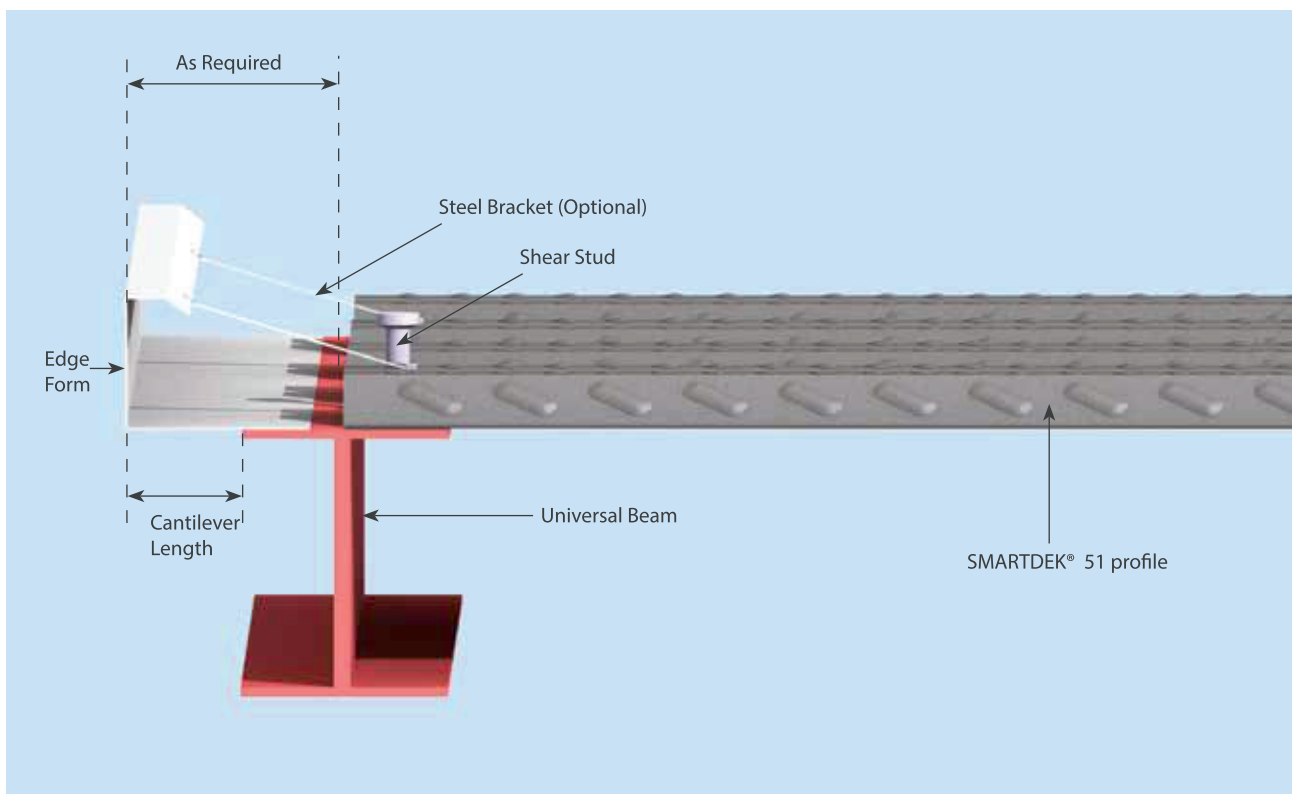

End details-Option 2: Alternate details for structures where projections are necessary

Above connection details for guidance purpose only.

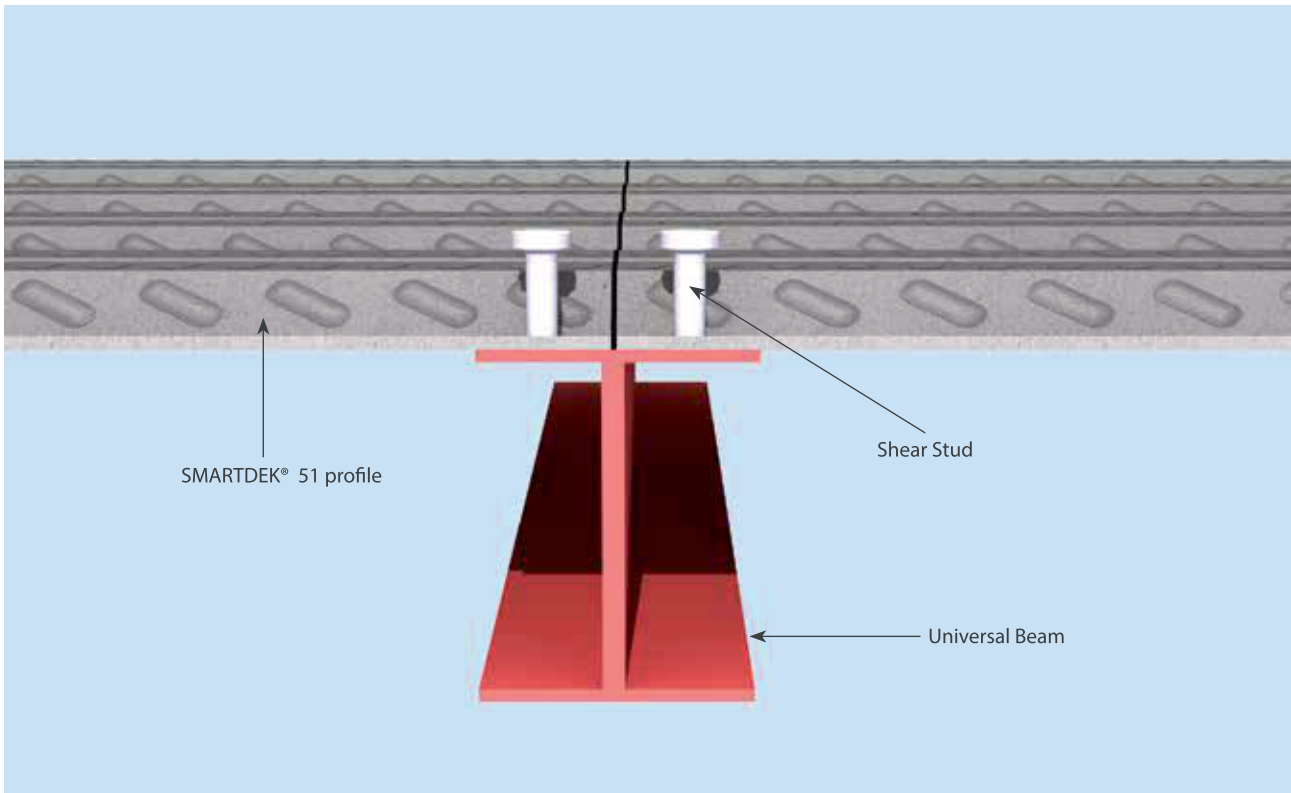

Butt joint details: Standard joint detail for continuous casting of slab

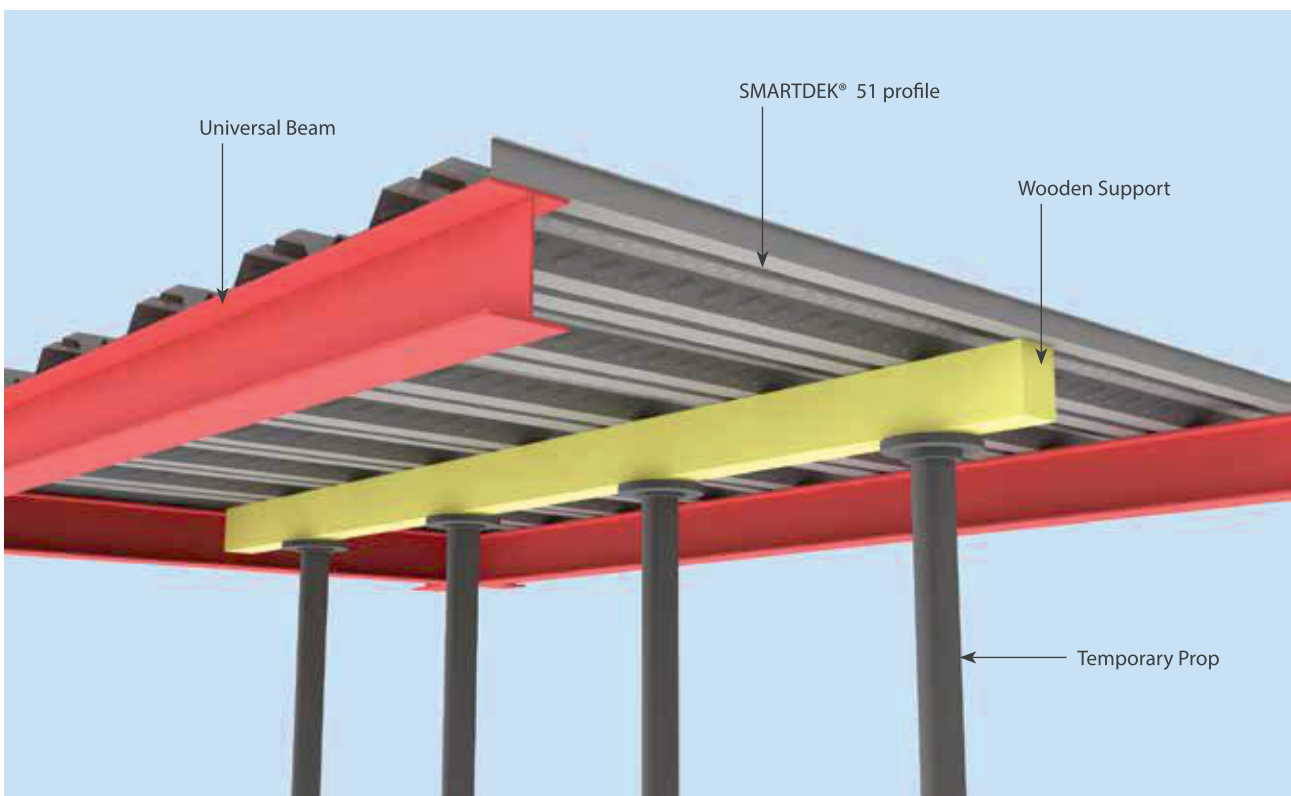

Temporary support details (If required): SMARTDEK® 51 profile spans longer than conventional system where possibility of temporary support is less. Please refer to SMARTDEK® 51 Design & Construction Manual for details

Above connection details for guidance purpose only.

Connection Details

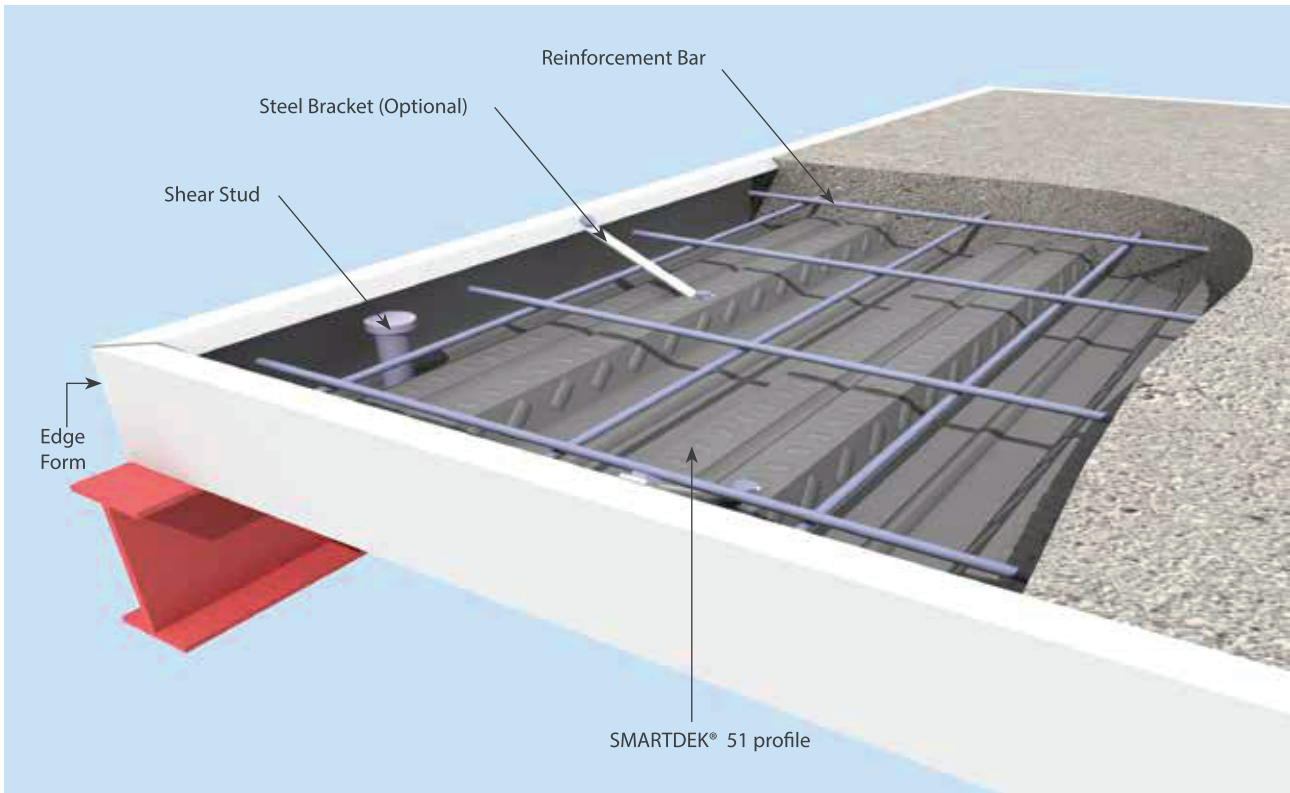

Corner details: The ends are closed to make sure the concrete slurry takes the required shape quickly

Concrete Connection Details

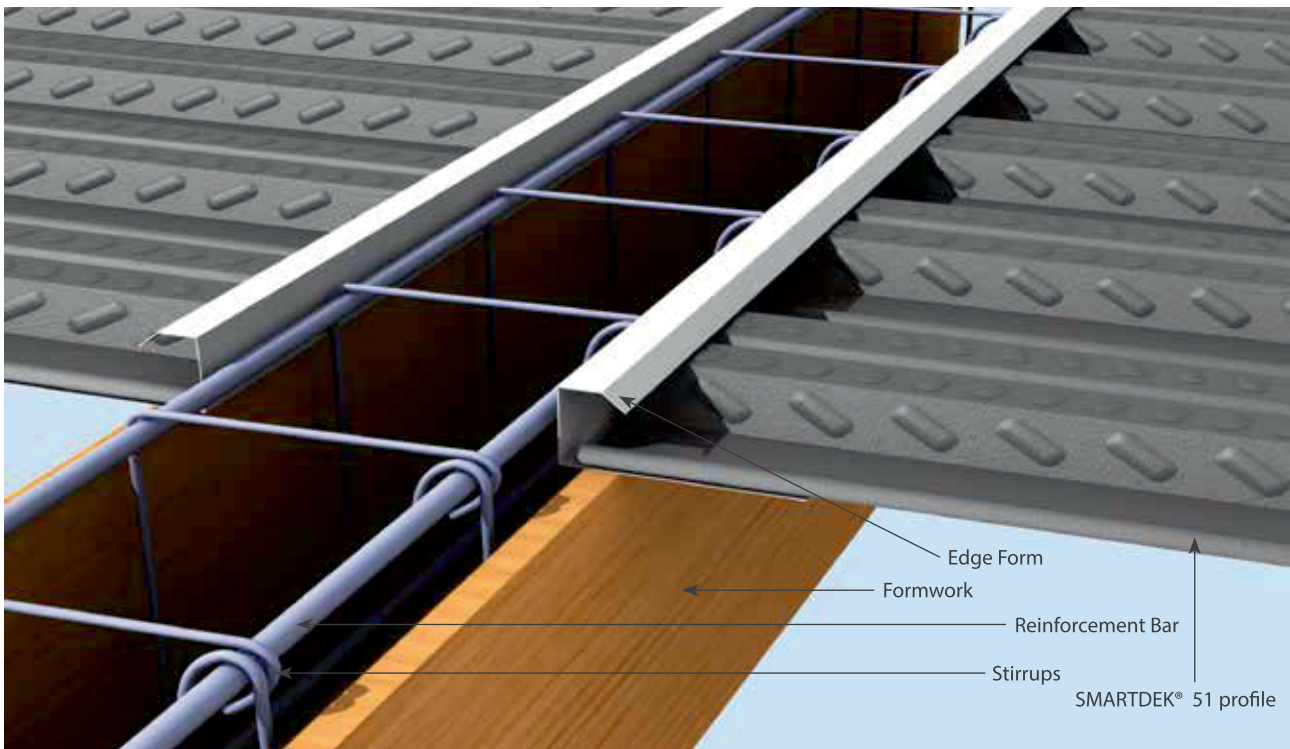

Concrete fixing details: The casting of beam & slab is done simultaneously. This saves time and brings economy.

Above connection details for guidance purpose only.

Fire Details

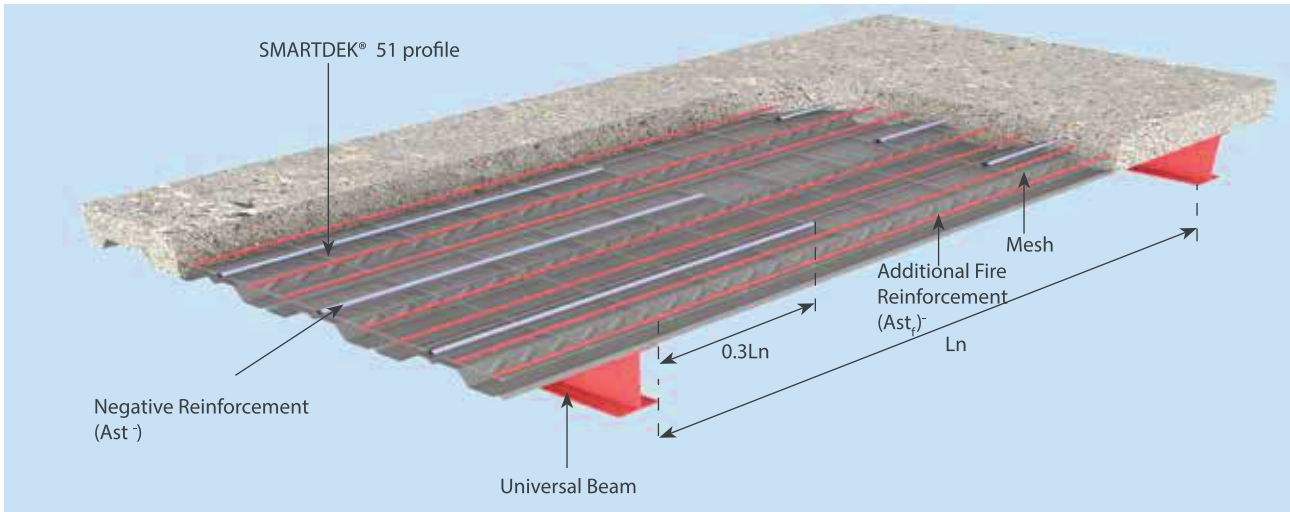

Option 1

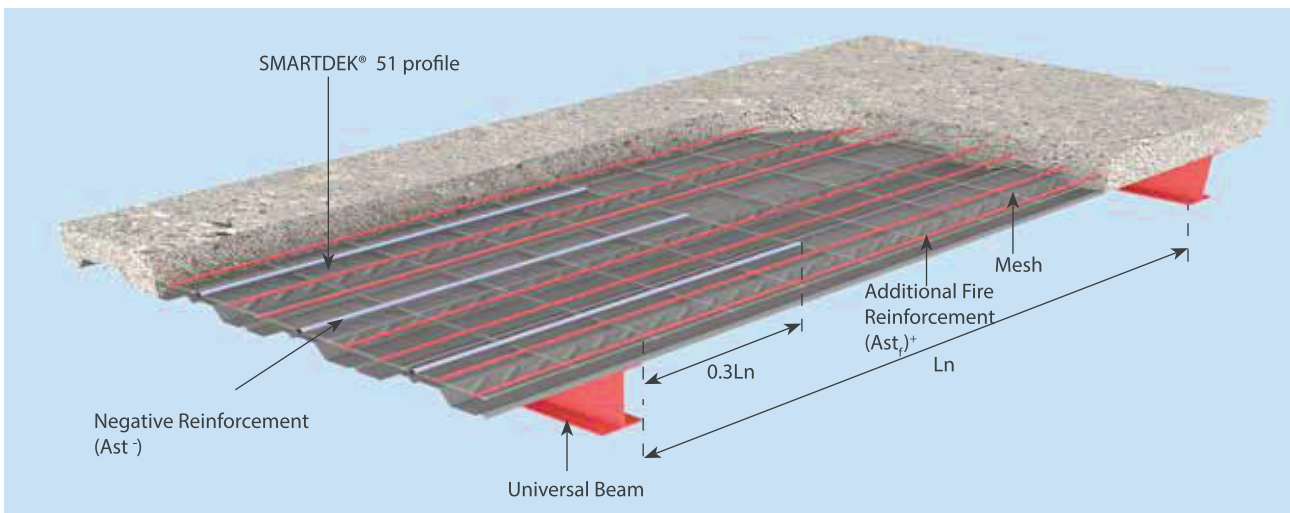

Option 2

*Above details for guidance purpose only.
Please refer SMARTDEK® 51 design and
construction manual*

Sequence of Construction



1 Open SMARTDEK® 51 sheet bundles



2 Place temporary support if required



3 Place on steel or concrete beam



4 Clinch male and female lip

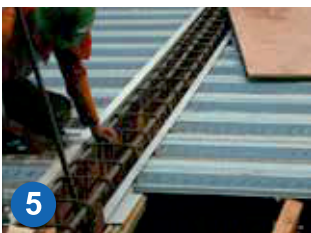

5 Fix steel edge form wherever required



6 Fix SMARTDEK® 51 profiles to steel or concrete beam



7 Place reinforcement



8 Place concrete

Benefits

- Excellent spanning capacities for greater strength and less deflection 1.2 mm BMT SMARTDEK® 51 can span more than 3 metres unpropped
- Embossments provide mechanical interlock ensuring adequate composite action
- SMARTDEK® 51 acts as bottom tensile reinforcement and eliminates the need of bottom rebars
- Precision engineered; brings greater economy and design freedom
- Ease of installation combined with safety
- Saves on concrete and reinforcement cost
- Greater corrosion resistance provides long life
- SMARTDEK® 51 composite slabs can be designed for up to 4 hours of fire rating



Global Excellence since 1857

Product Descriptions

- All descriptions, specifications, illustrations, drawings, data, dimensions and weights contained in this catalogue, all technical literature and websites containing information from LYSAGHT® are approximations only. They are intended by LYSAGHT® to be a general description for information and identification purposes and do not create a sale by description. LYSAGHT® reserves the right at any time to:
 - (a) Supply goods with such minor modifications from its drawings and specifications as it sees fit
 - (b) Alter specifications shown in its promotional literature to reflect changes made after the date of such publication

Disclaimer, Warranties and Limitation of Liability

- This publication is intended to be an aid for all trades and professionals involved with specifying and installing LYSAGHT® products and not to be a substitute for professional judgement
- Terms and conditions of sale available at local LYSAGHT® sales offices
- Except to the extent to which liability may not lawfully be excluded or limited, Tata BlueScope Steel will not be under or incur any liability to you for any direct or indirect loss or damage (including, without limitation, consequential loss or damage such as loss of profit or anticipated profit, loss of use, damage to goodwill and loss due to delay) however caused (including, without limitation, breach of contract, negligence and/or breach of statute), which you may suffer or incur in connection with this publication



Explore More



Toll Free: 1800 2708333

Email: contact@tatabluescopesteel.com

Note:

©2023 Tata BlueScope Steel Pvt. Ltd. All rights reserved. This brochure and its content is copyright of Tata BlueScope Steel Pvt. Ltd. No part of this brochure may be reproduced or transmitted in any form or by any means, electronic or mechanical including photocopy, recording, or any information storage and retrieval system, without permission in writing from Tata BlueScope Steel Pvt. Ltd.

All brand names mentioned in this brochure are registered trademarks of BlueScope Steel Limited under license to Tata BlueScope Steel Pvt. Ltd.

Authorised EZYBUILD® Solutions Provider



Tata BlueScope Steel Pvt. Ltd.
CIN : U45209PN2005PTC020270,
Floor no. 9 & 10, Kalpataru Infinia, Wakedwadi, Final Plot
no. 21, Sub plot no. 3 at CTS no. 15/1 Shivajinagar, Pune
- 411003, India. | Tel: +91 20 6621 8000
Website: www.tatabluescopesteel.com